

W Series Magnum Wine Rack 1

Spec Sheet for MAG1 (9-bottle wine rack)

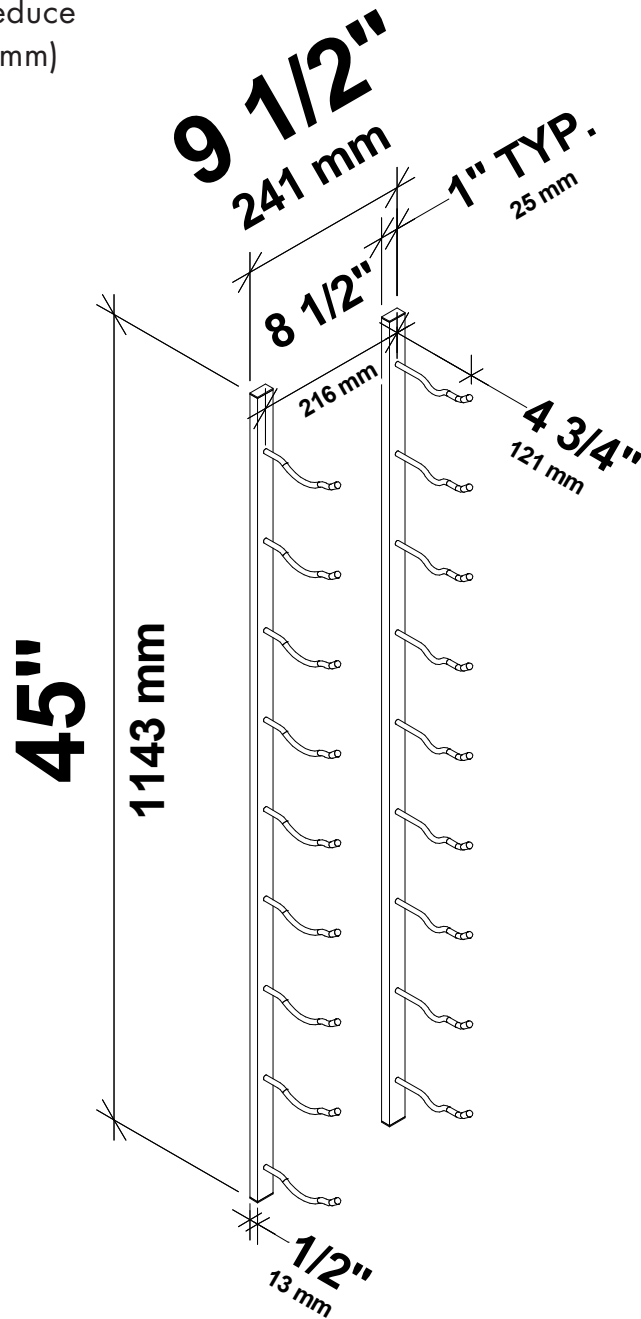

If using for Champagne or Pinot Noir bottles, reduce centerline by 1" (26mm)



SCAN FOR BILT. 3D INSTRUCTIONS



POWERED BY BILT INTELLIGENT INSTRUCTIONS®



VINTAGEVIEW®
MOVING WINE STORAGE FORWARD

4690 Joliet St., Denver, CO 80239 | phone: 866.650.1500 | fax: 866.650.1501 | VintageView.com

For product warranty information, please visit vintageview.com/warranty